

FEATURES	APPLICATIONS
<ul style="list-style-type: none"> <li>±20ppm (Frequency Stability) Available</li> <li>Ceramic Package</li> <li>CMOS</li> <li>RoHS Compliant</li> <li>Programmed VCXO</li> <li>Tape and Reel</li> </ul>	<ul style="list-style-type: none"> <li>Micro Processors</li> <li>FPGA</li> <li>Storage Area/Networking</li> <li>Digital Video</li> <li>Portable Computers</li> </ul>

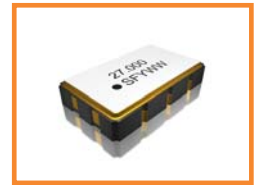

PART NUMBERING GUIDE	
<p><b>SUNTSU QUICK TURN VCXO</b> → <b>SQV 53 C 3 A 48 A 2 - 27.000M</b> ← <b>FREQUENCY (MHz)</b></p> <p><b>5.0mm x 3.2mm</b></p> <p><b>CMOS</b></p> <p><b>SUPPLY VOLTAGE</b> 2: 2.5V±5% 3: 3.3V±5%</p> <p><b>FREQUENCY STABILITY</b> A: ±50ppm B: ±30ppm C: ±25ppm *D: ±20ppm</p>	<p><b>TRI-STATE (ENABLE/ DISABLE)</b> BLANK: NO CONNECT 2: Pin 2</p> <p><b>PULLABILITY</b> A: ±150ppm B: ±100ppm C: ±50ppm</p> <p><b>OPERATING TEMPERATURE RANGE</b> 07: 0°C to +70°C 16: -10°C to +60°C 17: -10°C to +70°C 27: -20°C to +70°C 38: -30°C to +85°C 48: -40°C to +85°C</p>
<p>Cage Code: 4GUT4 To customize your parameters contact a Suntsu representative. * For frequency stability option D contact a Suntsu representative.</p>	

ELECTRICAL PARAMETERS	UNITS	MIN.	TYP.	MAX.	REMARKS
Frequency Range	MHz	8		1500	
Frequency Stability (Includes Initial Tolerance at 25°C, Frequency Stability over Operating Temperature, Output Load Change, Supply Voltage Change, and First Year Aging at 25°C.)	ppm	-20		+20	See part numbering guide for options.
Operating Temperature	°C	-40		+85	See part numbering guide for options.
Storage Temperature		-55		+125	
Supply Voltage (V <sub>DD</sub> )	2.5V Option	2.375	2.5	2.625	
	3.3V Option	3.135	3.3	3.465	
Current (I <sub>DD</sub> )	2.5V Option			35	
	3.3V Option			45	
Control Voltage (V <sub>C</sub> )	2.5V Option	0		2.5	
	3.3V Option	0		3.3	
Pullability	ppm	±50	±100	±150	See part numbering guide for options.
Linearity	%			10	
Output Load (CMOS)				15	
Output Logic Levels	Output Logic High (V <sub>OH</sub> )	0.9*V <sub>DD</sub>			
	Output Logic Low (V <sub>OL</sub> )			0.1*V <sub>DD</sub>	
Rise (T <sub>R</sub> ) and Fall (T <sub>F</sub> ) Time	ns			3	
Symmetry (Duty Cycle)	%	45	50	55	
Tri-State Input Voltage	Enable	0.7*V <sub>DD</sub>			No Connection.
	Disable			0.3*V <sub>DD</sub>	
Start-Up Time	ms			10	
Phase Jitter (12kHz ~ 20MHz)	ps		0.7	1.5	

OUTLINE DRAWING															
	<p>RECOMMENDED LAND PATTERN</p>														
<p>NOTE: Dimensions in millimeters (mm).</p>	<table border="1"> <thead> <tr> <th>PIN</th> <th>FUNCTION</th> </tr> </thead> <tbody> <tr> <td>1</td> <td>VOLTAGE CONTROL</td> </tr> <tr> <td>2</td> <td>TRI-STATE or NC</td> </tr> <tr> <td>3</td> <td>GND</td> </tr> <tr> <td>4</td> <td>OUTPUT</td> </tr> <tr> <td>5</td> <td>NC</td> </tr> <tr> <td>6</td> <td>V<sub>DD</sub></td> </tr> </tbody> </table>	PIN	FUNCTION	1	VOLTAGE CONTROL	2	TRI-STATE or NC	3	GND	4	OUTPUT	5	NC	6	V <sub>DD</sub>
PIN	FUNCTION														
1	VOLTAGE CONTROL														
2	TRI-STATE or NC														
3	GND														
4	OUTPUT														
5	NC														
6	V <sub>DD</sub>														

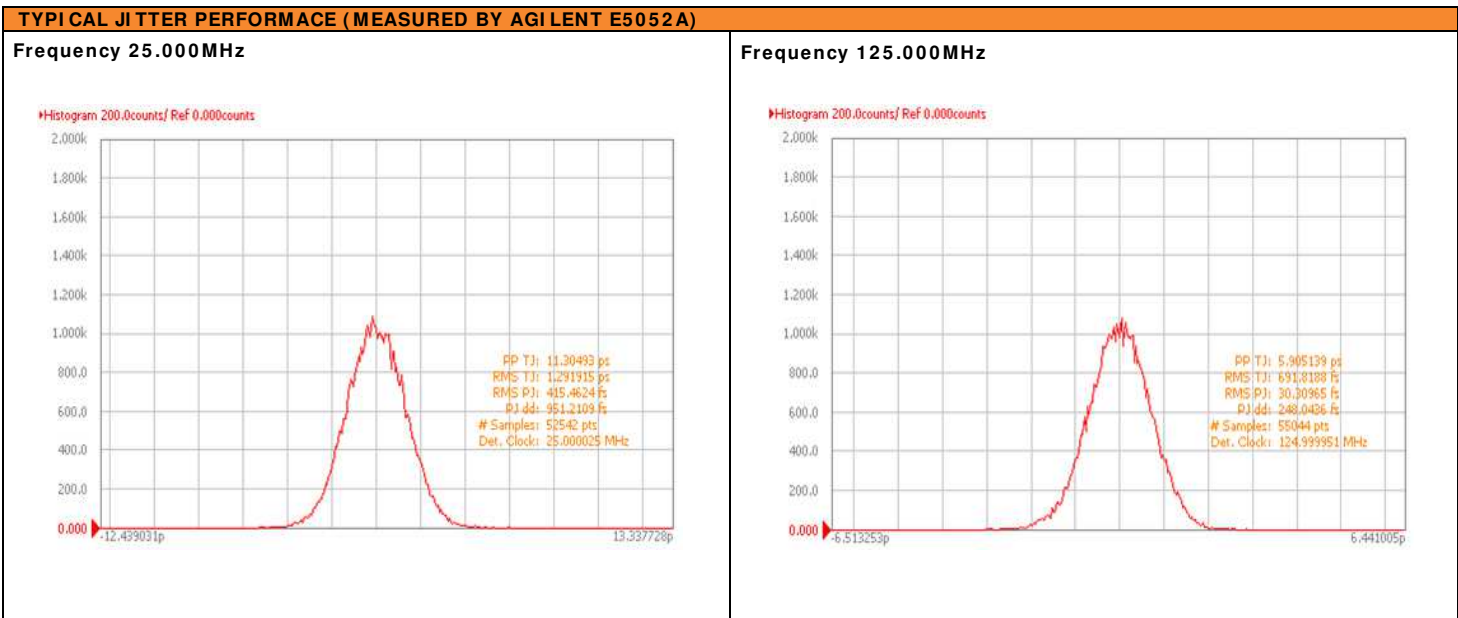
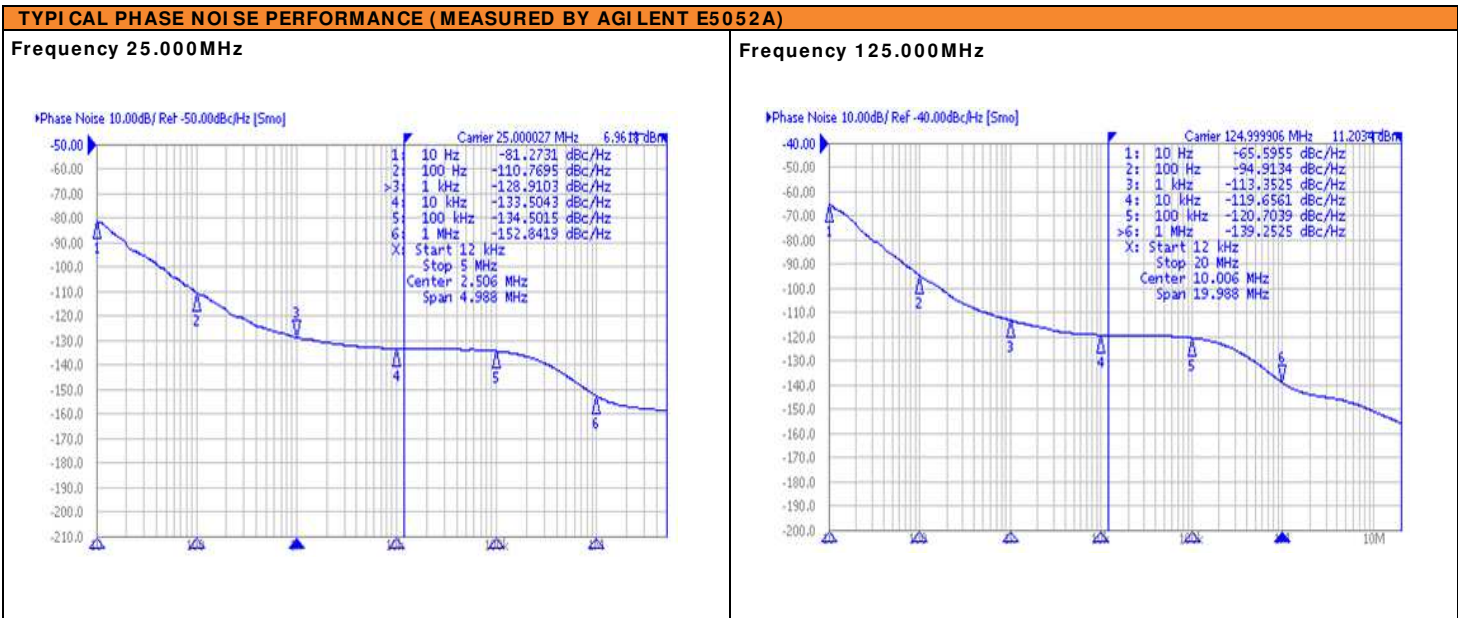
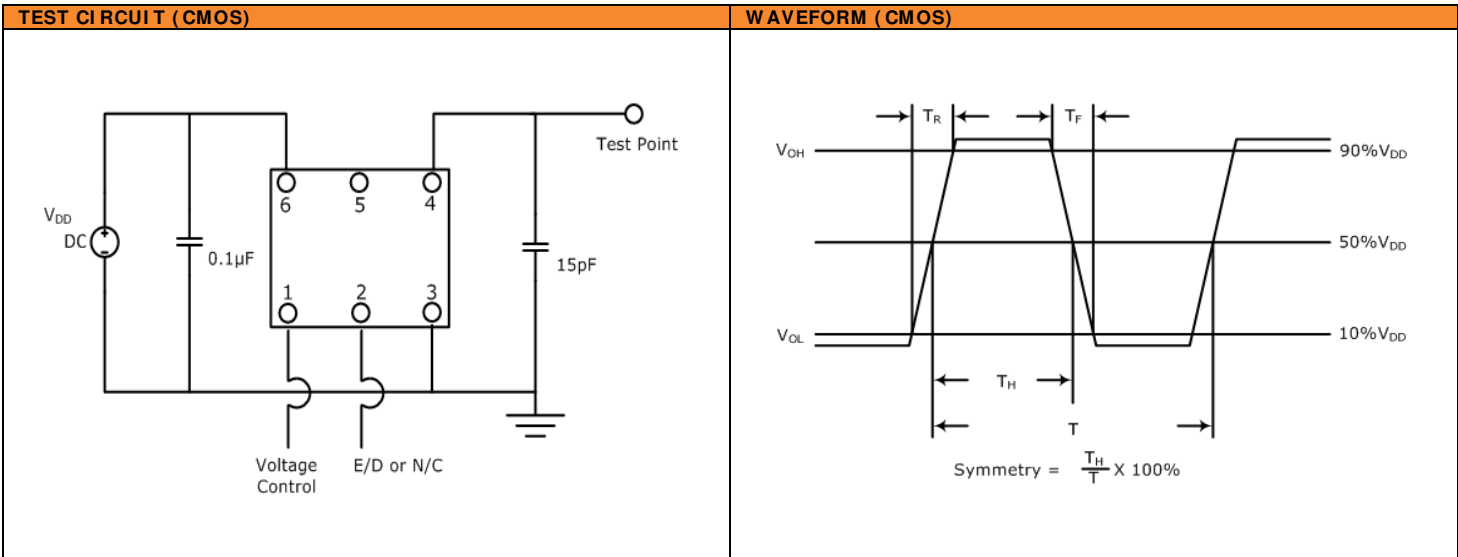

## ENVIRONMENTAL & MECHANICAL SPECIFICATIONS

Temperature Cycling	MIL-STD-883, Method 1010, Condition B
Fine Leak Test	MIL-STD-883, Method 1014, Condition A
Gross Leak Test	MIL-STD-883, Method 1014, Condition C
Mechanical Shock	MIL-STD-883, Method 2002, Condition B
Vibration	MIL-STD-883, Method 2007, Condition A
Moisture Resistance	MIL-STD-883, Method 1004
Moisture Sensitivity	J-STD-020, MSL 1
Resistance to Soldering Heat	MIL-STD-202, Method 210, Condition K
Resistance to Solvents	MIL-STD-202, Method 215
Solderability	MIL-STD-883, Method 2003

## REFLOW PROFILE

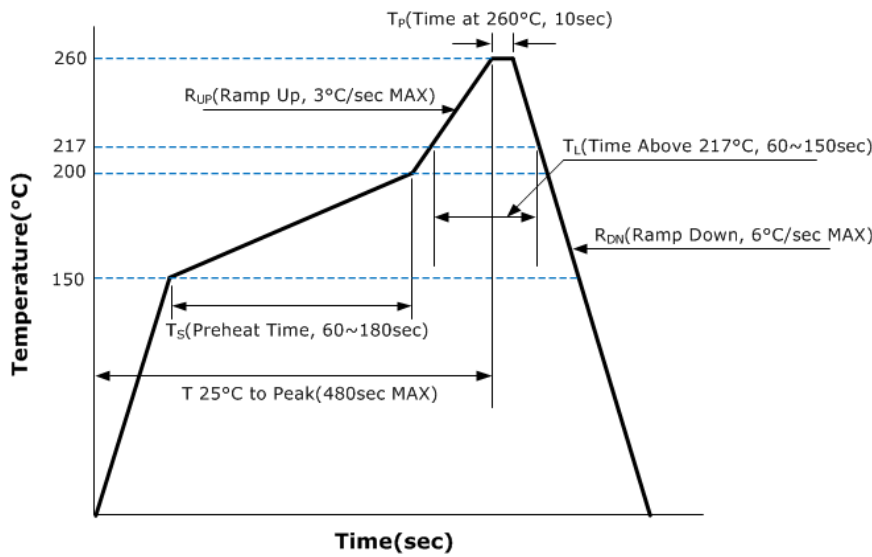

## MARKING

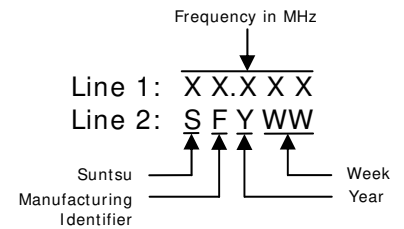

## TAPE AND REEL DIMENSIONS

1,000pcs/reel

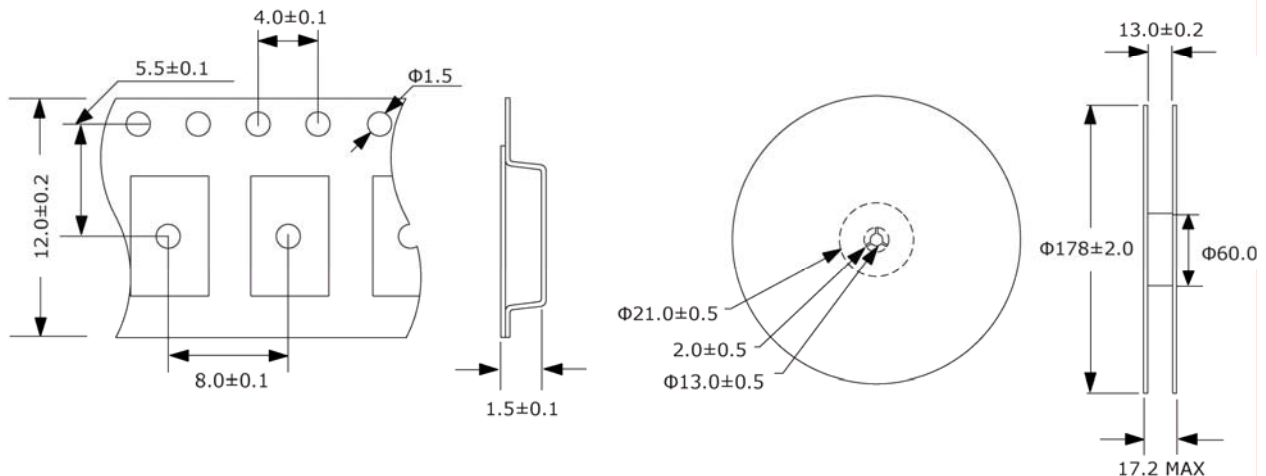

NOTE: Dimensions in millimeters (mm); drawing is not to scale.